

Pat.
Easyrig[®] 2.5

User Manual

Setup and
Adjustment

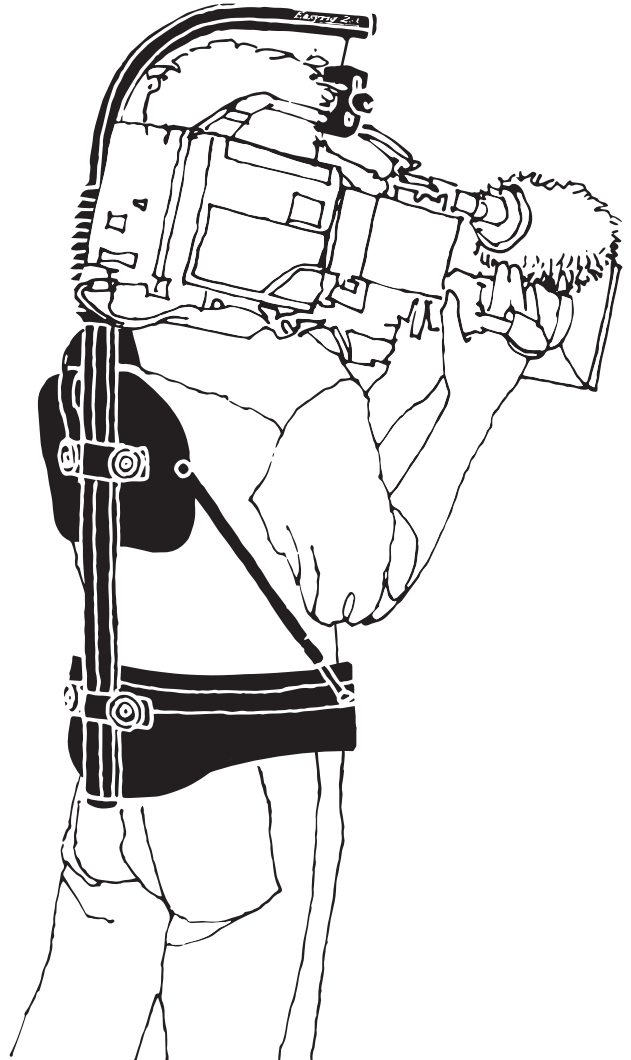

www.easyrig.com

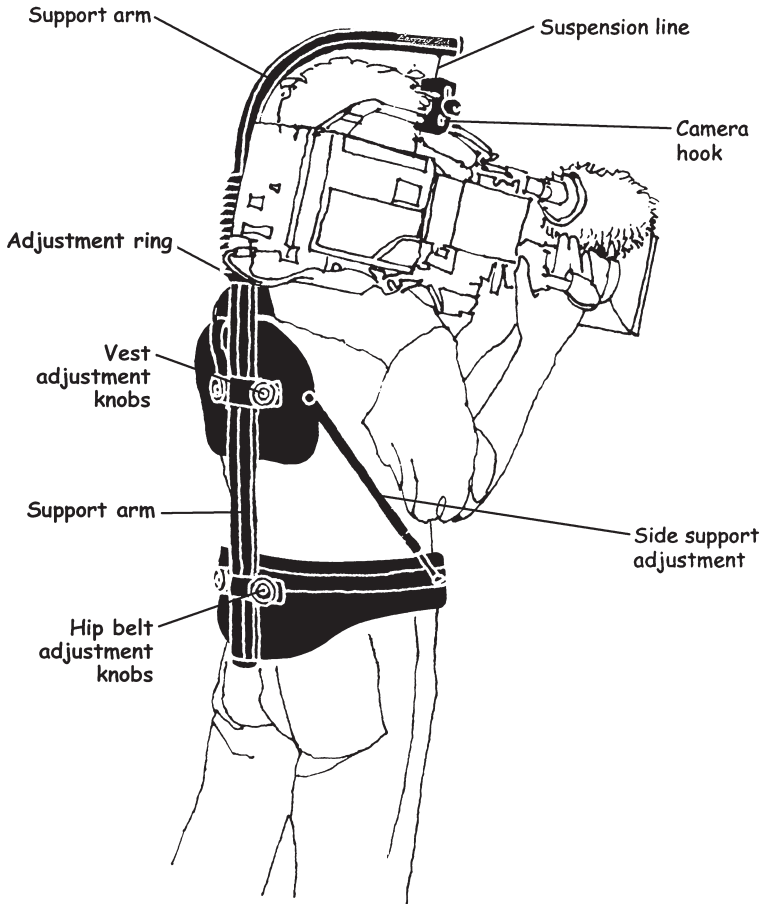

Weight	3,1-3,4 kg (6,8-7,5 lbs)
Height	90-100 cm (2'11"-3'3")
Suspension line (fully stretched)	88 cm (2'10")

— Made in Sweden —

Congratulations on your new Easyrig!

Easyrig is patented and specially designed by a photographer for professional photographers. It can be used with both video and film cameras. EASYRIG is manufactured in Sweden and has been ergonomically tested with optimal results.

EASYRIG gives you the advantages of both a handheld camera and tripod mounted camera; i.e. with the speed and mobility of the handheld camera you can still achieve steady pictures. EASYRIG relieves your back and shoulders. The load is redistributed to the hips so that you can concentrate on the actual filming. You won't suffer from a strained back or shoulders as you would from normal handheld shooting and you will be able to work for longer periods of time.

After you are finished with your Easyrig, just fold it and put it in the specially designed Petrol bag that your Easyrig is delivered in.

Easyrig will be your best tool when you do sport events, documentaries, news, yes, any occasion where handheld camera is required.

To get most out of your Easyrig, please read the user manual carefully.

Good luck!



Johan Hellsten

Using the Easyrig

It is as simple to put the Easyrig on as it is with a backpack. Just don't forget to adjust it so it feels comfortable.

The weight of the camera should primarily be on your hips. It is important that the support bar is vertical - if it is lopsided, the load will be unevenly distributed on the hips and the camera might hit the bar.

The hip belt should be tightened so that the rig doesn't slide down or around the hips. The shoulder strap is mainly for balancing the Easyrig, and prevent it from tilting.

If the support arm is too high or too low, first try adjusting the support bar in relation to the hip belt/vest, or change position of your hips. It is also possible to adjust the tube inside the support bar, but that might require adjusting the tightness of the suspension line. Note that there must not be more than 10 cm (4 in) between the lower end of the tube and the adjustment ring.

When attaching the hook onto the camera, you might find it easier to put the camera on a table or a bench first. Try and find the right balance before you secure the hook.

Don't forget to fasten the safety line.

Hip shots

Easyrig gives you the freedom to shoot from various levels. You simply move the camera down from your shoulder as you would in an ordinary handheld situation - only now you don't feel more than a fraction of the camera's weight.

When shooting at hip level, lean backwards when pushing the camera forward, thus minimising the load on your back.

The length of the suspension line makes it possible to move the camera as far as your arms reach.

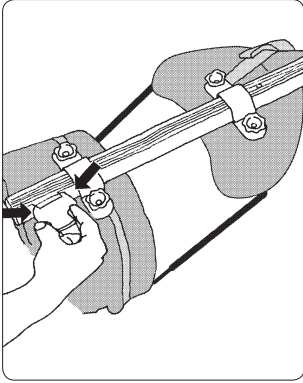

Fig. 1
Undo the buckle and unfold the support arm.

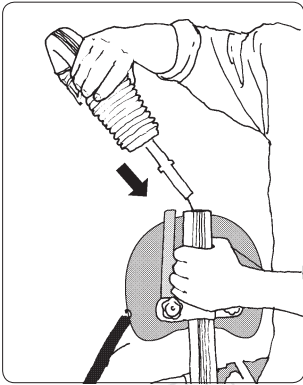

Fig. 2
Let the tube slide into the back support bar and pull over the bellows.



Fig. 2
Put on your Easyrig.
Adjust the hip belt until you find the rig comfortable.
Pull the belt tightly.

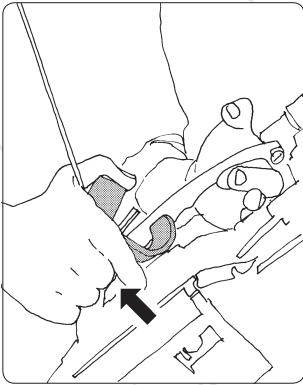

Fig. 4
Attach your camera to the Easyrig. Use your middle finger to open the hook. Secure the hook by turning the knob clockwise. Fasten the safety line.

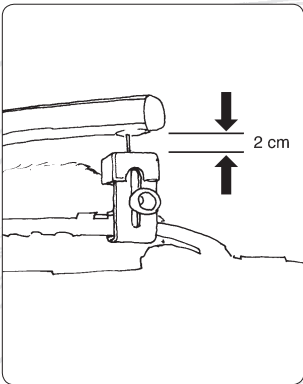

Fig. 5
Leave a gap of approx. 2 cm (1 inch) between the camera and the support arm.

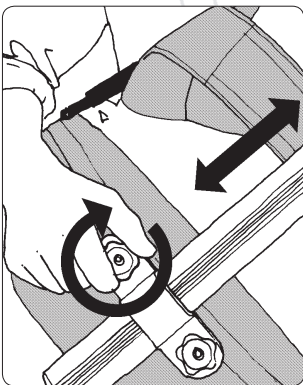

Fig. 6
If adjustment is needed, loosen the knobs and move the hipbelt and/or the vest to find the right position.

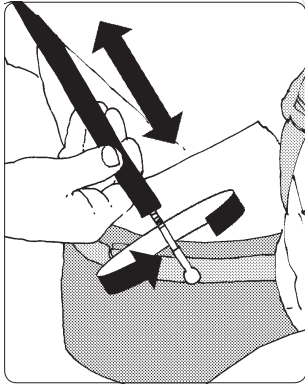

Fig. 7
By adjusting the side supports you will move the weight on your hips.

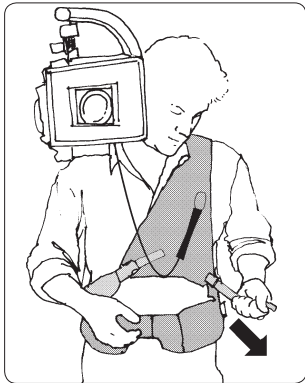
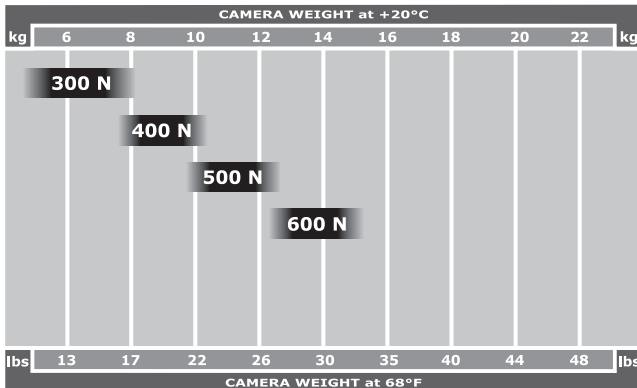

Fig. 8
Adjust the chest strap if necessary, but don't pull it too tight.
Your Easyrig is now ready to be used.

Different powered shock absorbers



Safety precautions

Always hold the camera when working with the Easyrig. There is a safety strap which you attach to the camera and hook onto the vest.

Never undo the hip belt buckle when the camera is attached to the Easyrig! The weight of the camera will pull the top of the Easyrig down, and you might lose control of the camera.

If you fall into water when wearing the Easyrig, it's important to get the equipment off quickly. Just release the hip belt and shoulder strap buckles and slide the shoulder strap over your arm.

Be especially careful when filming in rough terrain. Make sure you wear comfortable shoes and clothing.

If you work with the Easyrig under special conditions, i.e. in a car, boat, plane or helicopter, make sure to use a safety belt or harness.

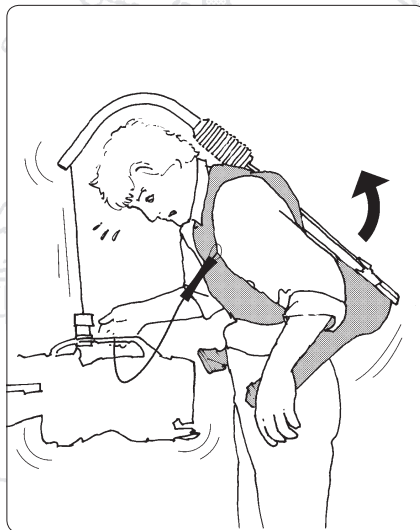

Some practical advice

Try to keep the camera as close to your body as possible, to avoid unnecessary strain on your back.

When filming upwards, you might find it easier if you have the camera tucked under your arm.

When filming at hip or knee level, you can remove the eye piece in order to see better. You could also attach an LCD screen, to get better control of the shot.

When shooting at hip level during longer periods of time, rest the camera on the hip belt to increase stability.

Avoid getting your clothing creased under the hip belt since it may cause discomfort.

Use the Easyrig for transporting your camera to and from the filming site.

When folding your Easyrig, always make sure to put the upper part of the support arm inside the hip belt and fasten the buckle at the back of the hip belt. This will prevent the suspension line from wearing.

When filming with a cable, fasten it to the Easyrig in order to maintain stability.

If you don't use your Easyrig for more than a couple of months, make sure to store it standing up. Otherwise the shock absorber gasket might dry out.

"Easyrig is an effective ergonomic relief aid for back and shoulders, intended for TV cameramen working with hand held cameras. A considerable load relief has been ascertained. The aid provides a good basis for improvement of back health. The results show that this aid can give longterm benefits in the form of improved back health, work effectiveness and picture quality."

Elisabeth Schell, Authorised ergonomist and registered physio-therapist, Swedish Television.

Easyrig limited Warranty

Manufacturer's products are warranted to be free from defects caused by faulty materials or workmanship for a period of two years from the date of purchase. The liability of the Manufacturer under this warranty is limited to repairing, replacing, or at its option issuing credit for any of its products which are returned by purchaser during such period provided, however, that:

A. Warranty card is properly filled out and returned to Manufacturer within 30 days of purchase.

B. Defective merchandise is returned to Manufacturer accompanied by a report of findings indicating the basis of/for rejection and with transportation charges paid by the purchaser.

C. That such defects exist and have not been caused by abuse, misuse, neglect, improper installation or assembly, repair, alteration or accident.

In no event shall Manufacturer be liable for collateral or consequential damages of any nature. This warranty is in lieu of all other warranties expressed or implied.

Easyrig Warranty Information card

Please mail within 30 days of purchase.

Name _____ Title _____

Company _____ Type of business _____

Address _____

City _____ Postal code _____

Country _____

Phone: _____

e-mail: _____

Easyrig serial No: _____

Purchase location/company: _____ Date: _____

Please send to:

Easyrig AB
Anumark 231
S-905 95 Umeå
Sweden
Phone: +46 90 77 60 01

